

COMPETENCE B 4130

The switchable built-in oven

Operating Instructions



Dear Customer,

Please read these operating instructions through carefully.

Above all, please take note of the "Safety" section on the first few pages. Please keep these operating instructions for later reference. Pass them on to any subsequent owner of the appliance.



The warning triangle and/or specific words (**Warning!**, **Caution!**, **Important!**) are used to highlight instructions that are important for your safety or for the function of the appliance. It is imperative that these instructions are observed.



1. This symbol guides you step by step when operating the appliance.

2. ...

3. ...



Next to this symbol you receive additional information and practical tips on using the appliance.



Tips and information about the economical and ecological use of the machine are marked with a cloverleaf.

In the event of a malfunction, these operating instructions contain information on how to rectify faults yourself, see the "What to do, if..." section.

In the event of technical problems, our local FACTORY CUSTOMER SERVICE CENTRE is always available to provide assistance (you will find addresses and telephone numbers in the "Customer Service Centres" section).

Please also take note of the contents of the "Service" section.

Printed on paper manufactured with environmentally sound processes.
He who thinks ecologically acts accordingly ...

CONTENTS

Operating Instructions	5
Safety Instructions	5
Disposal	7
Appliance structure	8
Control panel	8
Oven Features	9
Oven Accessories	10
Oven Functions	11
Before using for the first time	12
Setting/Changing the Time	12
Cleaning for the first time	13
Operating the Oven	14
Inserting/Removing the Fat Filter	14
Inserting the Shelf and Universal Sheet	14
Switching the Oven On and Off	15
Using the Automatic Function	16
Automatic Switching Off	16
Automatic Switching On and Off	17
Checking Automatic Programme Settings	17
Changing Automatic Programme Settings	17
Cancelling an Automatic Programme	18
Information on the Automatic Function	18
Countdown	19
Changing the Signal Tone	19
Meat Thermometer	20
Usage, Tables and Tips	21
Baking	21
Baking Tables	23
Pies and Gratins Table	27
Frozen Ready Meals Table	27

Fry	28
Roasting Table	29
Meat Thermometer Table	31
Grilling	32
Grilling Table	32
Preserving	33
Preserving Times	33
Cleaning and Care	34
The Exterior of the Appliance	34
Oven Interior	34
Accessories	34
Fat Filter	34
Side Rails	35
Grill Element	36
Oven Light	37
Oven Door	38
Oven Door Glass	40
What to do if	41
Special accessories	42
Installation Instructions	44
Technical Data	44
Regulations, Standards, Directives	44
Safety Instructions for the Installer	45
Installation	46
Service and Spare Parts	51

OPERATING INSTRUCTIONS



Safety Instructions

The new appliance may only be assembled and connected by an **approved installer**.

Please observe this instruction, otherwise the warranty will not cover any damage that may occur.

The safety features of AEG electrical appliances comply with accepted technical standards and the German Appliance Safety Law. However, we also consider it our obligation as a manufacturer to make you aware of the following safety information.

General Safety

- When using other electrical appliances ensure the cable does not come into contact with the hot surfaces of the oven.
- Do not store flammable substances in the oven. They could ignite when the oven is switched on.
- For safety reasons do not clean the appliance with a steam or high pressure cleaner.
- If force is used, especially on the edges of the front pane of glass, the glass may break.
- When cooking, roasting and grilling the oven door will become hot. **Therefore always keep small children away from the door.**
- Overheated fat and oil can catch fire quickly. Please always stay close to the appliance when preparing food in fat or oil (e.g. chips).
- If you use alcoholic ingredients in the oven, it is possible that an easily ignitable alcohol-air mixture might be produced. In this case open the door very carefully. When doing so, avoid having any hot embers, sparks or open flames in the immediate vicinity.
- **Repairs to the appliance may only be performed by qualified service engineers.** Improper repairs can give rise to significant hazards. If your appliance needs repairing, please contact your local AEG Service Force Centre.
- In the case of the appliance malfunctioning: remove the fuses or switch off the circuit breaker.

Intended Use

- This appliance must not be used for purposes other than that intended, it must only be used for the cooking, roasting and baking of food in the home.
- Only use the appliance to prepare food.
- Do not use the oven to heat the room.

In this way you avoid damaging your appliance

- Do not line your oven with aluminium foil and do not place a baking sheet or dish on the oven floor, otherwise the oven enamel will be damaged by the resulting build up of heat.
- Clean the appliance after each use. Spills are then easier to clean up and do not become burnt onto the surface.
- Any drops of fruit juice that fall from the baking sheet will leave spots that cannot be removed. Use the universal sheet for very moist cakes.
- Never pour water directly into the hot oven. The enamel may be damaged.
- Do not sit on the open oven door.
- Do not store moist food in the oven.

Eco-Insulation

In the factory the oven is fitted with eco-insulation. This insulation has been tested for pollutants by independent test institutes and categorised as harmless



Disposal

Disposing of the packaging materials

All materials used can be fully recycled.

The plastics are marked as follows:

- >PE< for polyethylene, e.g. as used for the outer wrapping and the bags inside.
- >PS< for polystyrene foam, e.g. as used for the packing pieces, completely free of CFCs.

The cardboard is made from 80% recycled paper.

Disposal of old appliances

All old appliances must be correctly disposed of for environmental reasons.



Warning! When disposing of an old appliance, make it unusable by cutting off the cable. Remove any door catches to prevent small children being trapped inside.



Information on disposal

- The appliance must not be disposed of in the household rubbish.
- You can obtain information about collection dates or public tips from your local refuse department or council.

Appliance structure

Control panel

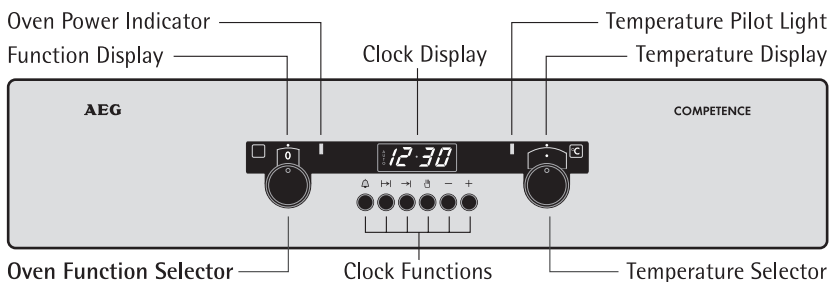

Oven Function Selector and Function Display

Retractable rotary knob, used for selecting the required oven function. The oven function selected is indicated in the oven function display.

Temperature Selector and Temperature Display

Retractable rotary knob, used for selecting the required oven temperature. The oven temperature selected is indicated in the temperature display.

Clock Functions and Clock/Meat Thermometer Display

Buttons for setting the clock functions. The clock display indicates the current time or the time set on the interval countdown. When the meat thermometer is used, the actual and required meat core temperatures are displayed.

Oven Power Indicator

The oven power indicator illuminates as soon as the oven is switched on.

Temperature Pilot Light

The temperature pilot light illuminates while the oven is heating up and extinguishes when the selected temperature is reached. It then cycles on and off during cooking to show that the temperature is being maintained.

Oven Features

Shelf Positions

There are side rails on both sides of the oven, each of these has 6 shelf positions.

Please note that the shelf positions **are counted from top to bottom.**

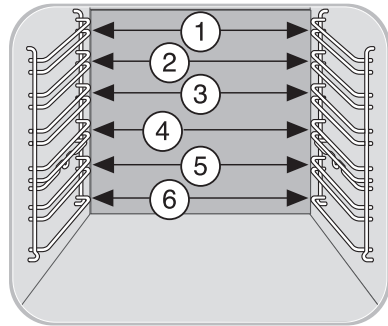

Anti-Tip Device

All slide-in parts are fitted with an anti-tip device to prevent them being unintentionally pulled all the way out.

When inserting slide-in parts, the anti-tip device must be at the rear.

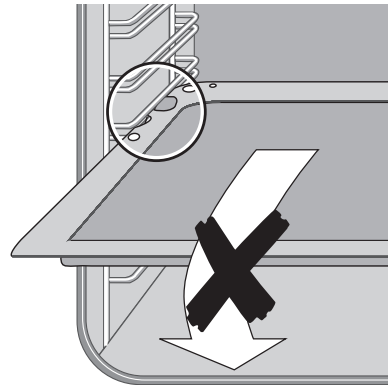

Fat Filter

The fat filter supplied with your appliance protects the fan in the rear wall of the oven from soiling.

Always use the filter when **roasting** uncovered food or using hot air or Rotitherm.

Fan

The fan switches on automatically as soon as the oven is put into operation. The fan continues to run after the oven has been switched off to cool the appliance; it switches off automatically.

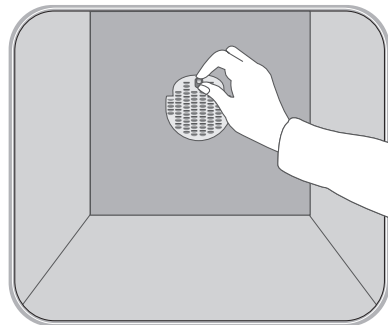

Oven Accessories

The following items are supplied:

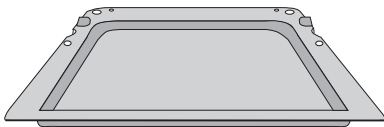

Baking Sheet

For cakes and biscuits

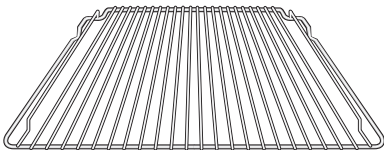

Combination Shelf

For dishes, cake tins, ovenware for roasting and grilling

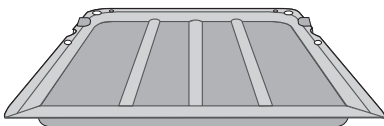

Fat Tray

For roasting or for collecting fat



Meat Thermometer

For the precisely defining the degree to which joints of meat are cooked.

Oven Functions

The following functions are available for the oven:

Fan Cooking

Fan cooking is particularly suited to **baking** on **several levels** at the same time.

Oven temperatures are generally 20–40 °C lower than for conventional heat.

A ring heater and part of the bottom element are used.

In addition a fan in the rear wall of the oven ensures that the hot air in the oven is circulated continuously. The food is heated from all sides.

Conventional

Conventional is suited to **baking** and **roasting** on **one level**.

Heat is supplied evenly from above and below.

Rotitherm

Rotitherm is particularly suited to **grilling** or **roasting** larger pieces of meat or game on one level. This function is also suitable for 'au gratin' dishes and **browning**.

The grill element and fan are used simultaneously.

Pizza & Baking

Using this function you can **bake** cakes on **one level**.

This function is also suitable for dishes that require more intensive browning and a crispy base, e.g. pizzas, quiche Lorraine, cheesecakes, etc.

Oven temperatures are generally 20–40 °C lower than for conventional heat.

Conventional heat is used and the fan is also switched on.

Grill

Grilling is particularly suited to the **grilling** or **toasting** of flat foods, for example, steaks, cutlets, fish or toast.

The heat is provided by the grill element on the roof of the oven.

Before using for the first time



Setting/Changing the Time



The time display will flash after the electrical supply is connected.

You must then first set the time.

If the time has not been set, the oven cannot be switched on.

Setting the Time

1. Press the  button.
2. Set the current time within 5 seconds using the  or  buttons.
The time appears in the display.
The oven is now ready for use.

 By pressing the  or  button for more than 2 seconds, the minutes will start to run forwards or backwards until the button is released again. By this means you can reach the required setting quicker.

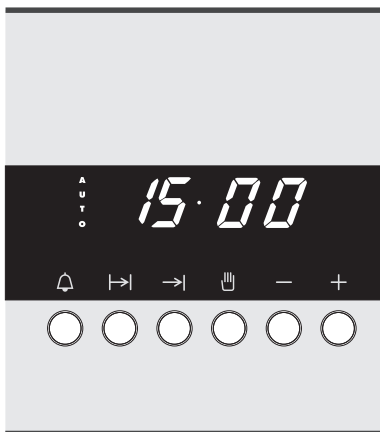



 If the appliance has been isolated from the mains, e.g. due to a power failure, the time display will flash again. In this case reset the time again, as described above.

Changing the Time

If you wish to correct the time, e.g. on the change over from summer to winter time, repeat the process described under "Setting the Time".

Cleaning for the first time

Before you use the oven for the first time, you should clean it thoroughly. You can switch on the oven light to make cleaning easier.

-  **1.** Turn the oven function control knob to oven lighting .
- 2.** Remove all accessories and the side rails and wash with warm water and washing up liquid.
- 3.** Also wash out the oven with warm water and washing up liquid, and dry.
- 4.** Clean the front of the appliance with a damp cloth.



Tip: Use commercially available cleaner for stainless steel fronts that at the same time also form a protective film against finger marks.



Important: Do not use any caustic or abrasive cleaners! The surface could be damaged.

Operating the Oven

Inserting/Removing the Fat Filter

Always use the fat filter when **roasting** without any covering in open roasting dishes.



Inserting the Fat Filter

Take hold of the fat filter by the tab and insert the two retainers in the opening on the rear wall of the oven (fan opening) from the top downwards.

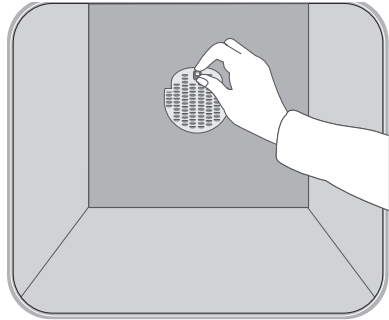

Removing the Fat Filter

Take hold of the tab on the fat filter and remove upwards.

Inserting the Shelf and Tray

All slide-in parts have a small protrusion on the right and left. This protrusion serves as an anti-tip device and must point downwards.



Inserting a Shelf

Insert the **shelf** such that the two guide rails point upwards. The anti-tip device must point downwards and be in the rear of the oven.

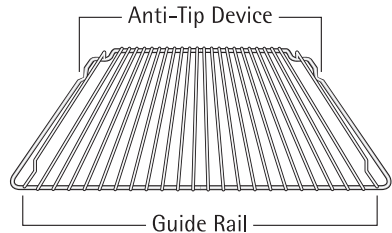

Inserting the Shelf and Tray

When the **shelf and fat tray** are used together, carefully place the shelf anti-tip device in the protruberances on the fat tray.

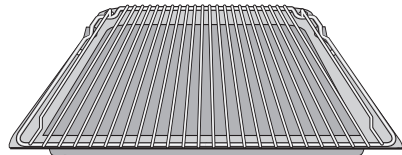

Switching the Oven On and Off

1. To use, press the "Oven Functions" and "Temperature Selection" switches as necessary.
The switches then protrude.
2. Set the required function by turning the "Oven Functions" switch.
The functions display indicates the symbol for the function selected.
3. Set the required temperature by turning the "Temperature Selection" switch.
The temperature display indicates the temperature selected.

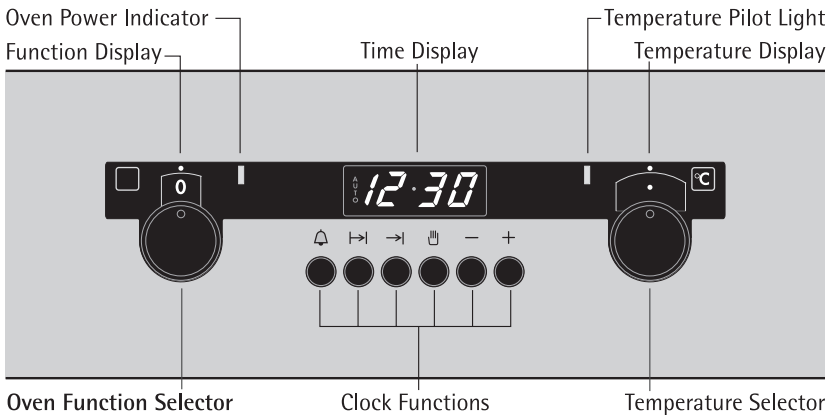

The oven power indicator illuminates as long as the oven is in operation.

The temperature pilot light illuminates whilst the oven is heating up. When the temperature set is reached, the temperature pilot light extinguishes.

4. To switch off the oven, turn the "Oven Functions" switch and the "Temperature Selection" switch to the zero position.
5. Lower the switches by pressing them.

Using the Automatic Function



There are two ways of using the automatic function:

- **Automatic Switch Off:** When you have the oven switched on and simply do not want to forget to switch it off at the right time, you can use the clock to set either the **duration** or the **end** of the cooking time. The oven then switches itself off automatically.
- **Automatic Switching On and Off:** When, for example, in the morning or at lunch time you want to prepare a dish for the evening, you can set the **duration and also** the **end** of the cooking time. The oven then switches on automatically at the calculated start time, and switches off again automatically at the end of cooking.
 - **Example:** The roast requires cooking for 1 hour: COOK TIME = 1.00. The roast should be ready at 18:00: END TIME = 18.00.

The oven function can be selected either before or after setting the automatic function.



Automatic Switching Off

1. Select the required oven function.
2. Select the required temperature.
3. Press the "COOK TIME"  button.

4. Set the required cooking time within 5 seconds using the  and  buttons.

The "AUTO" symbol illuminates and indicates that the oven is set up in automatic mode.









As soon as the cooking time is at an end, the oven switches off automatically. The "AUTO" symbol flashes and an acoustic signal sounds for approx. two minutes.

5. Press the "COOK TIME"  button to switch off the signal.
6. Press the "MANUAL"  button.



The "AUTO" symbol extinguishes. The oven is now set again to manual mode.
7. **To switch off the oven, turn the oven function and temperature selectors to the off position.**

Automatic Switching On and Off

For automatic switching on and off both the duration and the end of the cooking time must be entered.





1. Select the required oven function.
2. Select the required temperature.
3. Press the "COOK TIME"  button and, using the  and  buttons, within 5 seconds set the required cooking time.
4. Press the "END TIME"  button and using the  and  buttons, within 5 seconds set the time when you want the meal to be ready. Once the entries have been made, the current time is again shown in the display. The "AUTO" symbol illuminates and indicates that the oven is set up in automatic mode. The oven switches on automatically at the calculated start time. When the cooking time is at an end, the oven switches off automatically. The "AUTO" symbol flashes and an acoustic signal sounds for approx. two minutes.
5. Press the "COOK TIME"  button to switch off the signal.
6. Press the "MANUAL"  button. The "AUTO" symbol extinguishes. The oven is now set again to manual mode.
7. **To switch off the oven, turn the oven function and temperature selectors to the off position.**

Checking Automatic Programme Settings



1. Press the "COOK TIME"  or "END TIME"  button. The duration or the end of the cooking time set is displayed respectively.

Changing Automatic Programme Settings

You can still change the duration or the end of the cooking time during cooking.

1. Using the "COOK TIME"  button call up the cooking time, or using the "END TIME"  button, the end of the cooking time.
2. Within 5 seconds press the  or  button until the cooking time or the end of the cooking time is set to the new time you require.

Cancelling an Automatic Programme

1. Using the "COOK TIME"  button call up the cooking time again.
2. Within 5 seconds set all entries to "0" using the  button.
3. Turn the oven function selector and the temperature selector to the off position.







Information on the Automatic Function

The maximum COOK TIME that can be set is 10 hours.

Countdown



The countdown operates independently and can therefore be set when the oven is switched on as well as switched off.

Setting the Countdown

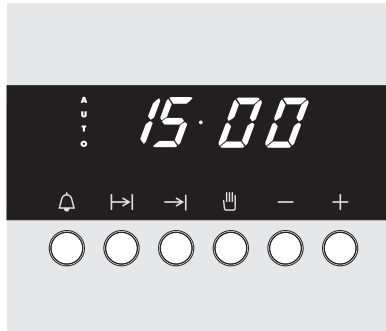

1. Press the "CLOCK"  button.
2. Set the time required within 5 seconds using the  and  buttons.
When the time set on the countdown has expired, an acoustic signal sounds for approx. two minutes.
3. Press the "CLOCK"  button to switch off the signal.



Changing the Setting on the Countdown

1. Using the "CLOCK"  button, re-select the time set on the countdown.
2. Set the new time required within 5 seconds using the  or  buttons.

Switching Off the Countdown Early

1. Using the "CLOCK"  button, re-select the time set on the countdown.
2. Within 5 seconds set the time required to "0" using the  button.



Checking the Countdown Setting

A few seconds after the countdown has been set, the time display indicates the current time again. You can check the amount of time left on the countdown at any time.

1. Using the "CLOCK"  button, re-select the time set on the countdown. The time remaining on the countdown is displayed.

Changing the Signal Tone

The frequency of the signal tone can be set to 3 different tones.

1. Press the  button until the changed signal tone sounds and release. The frequency is set to the next level.
2. Press the  button again until the changed signal tone sounds and release. The frequency is set to the next level.

Meat Thermometer

Once the required meat core temperature has been set, the cooking time is controlled by the meat thermometer inserted in the food to be cooked.



Important: Only the meat thermometer supplied may be used! In the case of replacement, only use an original AEG spare part!

 **1.** Push as much as possible of the tip of the meat thermometer into the food to be cooked so that the point is in the centre of the food.

2. Insert the meat thermometer plug in the socket on the oven side wall.

3. Set the oven function and temperature required (see "Roasting Table").

After a few seconds 80 °C is displayed **on the right** of the temperature/time display as **the suggested temperature**.

The actual **meat core temperature** is displayed **on the left**.

4. If necessary, change the suggested temperature using the \oplus or \ominus button (see "Meat Thermometer Table").

The actual meat core temperature is displayed on the left throughout the cooking process.

As soon as the meat core temperature and the suggested temperature match, an acoustic signal sounds and the oven switches itself off automatically.

5. Press the  button to switch off the signal.

6. Turn the oven functions switch and the temperature selection switch to the zero position.

7. Unplug the meat thermometer and remove the cooked food from the oven with the meat thermometer still in place.

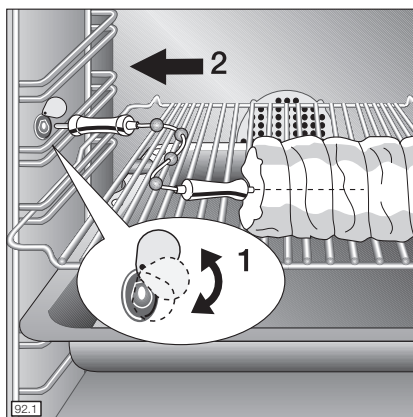



Caution: The meat thermometer is hot! There is a risk of burns when unplugging and pulling out the tip!



The meat thermometer only starts to function from approx. 13 °C.

Usage, Tables and Tips



Baking

Use the pizza & baking , fan cooking  or conventional heat  oven function for baking.





Important! Do not use a fat filter when baking!

Cake Tins

- Cake tins made of dark metal and coated tins are suitable for conventional heat .
- Light tins are also suitable for pizza & baking  and fan cooking .

Shelf Positions

- When using pizza & baking  or conventional heat  it is only possible to bake on one level.
- You can bake on up to 3 baking sheets simultaneously using fan cooking .

1 Baking Sheet:
Shelf Position 3

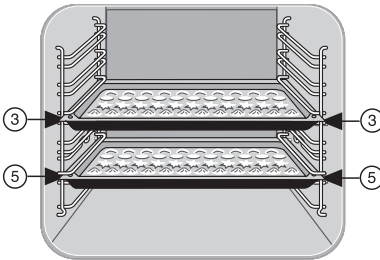

1 Cake Tin:
Shelf Position 5

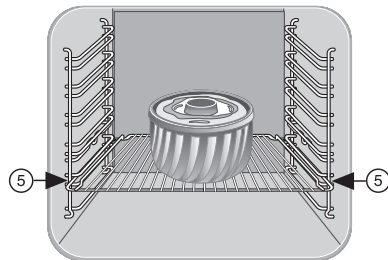

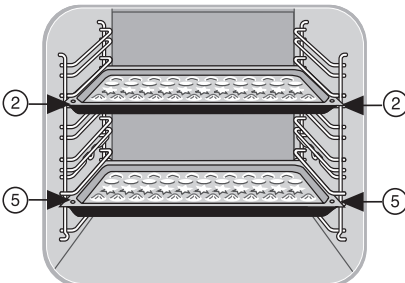

2 Baking Sheets:
Shelf Positions 2 and 5

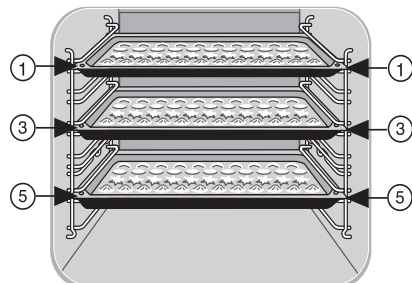

3 Baking Sheets:
Shelf Positions 1, 3 and 5



General information

- Please note that the shelf positions are counted from top to bottom.
- Insert baking sheets with the bevelled edge to the front!
- Slide the baking sheet to the rear wall.
- Always place cakes in cake tins in the middle of the shelf.
You can also bake two cakes simultaneously using pizza & baking  or conventional heat . In this case place the tins side by side on the shelf. The cooking time is then increased only slightly.

Notes on the Baking Tables

In the tables you will find information on temperatures, cooking times and shelf positions for a selection of recipes.

- Ranges are given for the temperature and cooking time since these are dependent on the mixture, quantity and cake tin used.
- When baking several cakes on baking sheets or in cake tins, the cooking time can be 10-15 minutes longer.
- Moist items (e.g. pizzas & baking, fruit cakes, etc.) should be cooked on a maximum of two levels.
- When using for the first time, we recommend setting the lower temperature, and only if necessary, e.g. if increased browning is required or the cooking time is too long, selecting a higher temperature.
- If you cannot find any specific information for one of your own recipes, use information on a similar recipe for guidance.
- Variations in the height of the item to be baked can lead to different degrees of browning at the start of baking. In this case, **please do not change the temperature setting**. Variations in the amount of browning will even themselves out during baking.





Switch off the oven 10-15 minutes before the end of the cooking time to make use of the residual heat.

The information in the tables applies, when not otherwise stated, for a cold oven.

Baking Tables

Baking on one level

Type of Cake or Pastry	Pizza & Baking 		Conventional 		Time for both functions Hr.: Min.
	Shelf Position from the Top	Tempera- ture °C	Shelf Position from the Top	Tempera- ture °C	
Cakes in Cake Tins					
Ring Cakes	5.	150-160	5.	160-180	0:50-1:10
Madeira Cake/ Koenigskuchen	5.	140-160	5.	150-170	1:10-1:30
Sponge Cake	4.	150-160	5.	160-180	0:25-0:40
Shortcrust Pastry Flan Base	3.	170-180	5.	190-210 ¹	0:10-0:25
Sponge Flan Base	3.	150-170	5.	170-190	0:20-0:25
Covered Apple Flan	5.	150-170	5.	170-190	0:50-1:00
Savoury Flan (e.g. quiche Lorraine)	5.	180-200	5./6.	180-200	0:30-1:10
Cheesecake	5.	140-160	5.	160-180	1:00-1:30
Cakes and Pastries on Baking Sheets					
Plaited Roll/Ring	3.	160-170	3.	170-190	0:30-0:40
Christmas Stollen	3.	160-170 ¹	3.	160-180¹	0:40-1:00
Bread (rye bread) firstthen	5.	180-200 ¹ 140-160	5.	250¹ 160-180	0:20 0:30-1:00
Cream Puffs/Eclairs	3.	160-170¹	3.	190-210	0:15-0:30
Swiss Roll	3.	160-170	3.	180-200¹	0:10-0:20
Dry Streusel Cake	3.	150-160	3.	160-180	0:20-0:40
Butter Cake/Sugar Cake, Bienenstich	3.	160-170 ¹	3.	190-210¹	0:15-0:30
Fruit Flan (on yeast pastry/sponge base) ²	3.	150-170	3.	170-190	0:25-0:50

Type of Cake or Pastry	Pizza & Baking 		Conventional 		Time for both functions Hr.: Min.
	Shelf Position from the Top	Tempera- ture °C	Shelf Position from the Top	Tempera- ture °C	
Fruit Flans on Shortcrust Pastry Base ¹	3.	160-170	3.	170-190	0:40-1:20
Flat Cakes with Delicate Toppings (e.g. curd cheese, cream)	3.	140-160	3.	160-180	0:40-1:20
Pizza & baking (with deep topping)	5.	180-200	5.	190-210 ¹	0:30-1:00
Pizza & baking (thin)	5.	200-220	5.	230-300 ¹	0:10-0:25
Unleavened Bread	3.	200-220	3.	270-300 ¹	0:08-0:15
Wähen (CH)	3.	180-200¹	5.	210-230 ¹	0:35-0:50
Biscuits					
Shortcrust Biscuits	3.	150-160	3.	170-190 ¹	0:06-0:20
Small Piped Biscuits	3.	140-150	3.	160-180 ¹	0:10-0:40
Sponge Fingers	3.	150-160	3.	170-190	0:15-0:20
Meringues	3.	80-100	3.	100-120	2:00-2:30
Macaroons	3.	100-120	3.	120-140	0:30-0:60
Small Pastries with Yeast	3.	160-170	3.	170-190	0:20-0:40
Small Pastries made from Puff Pastry	3.	170-180¹	3.	190-210 ¹	0:20-0:30
Bread Rolls	3.	180-200¹	5.	180-220 ¹	0:20-0:35

1) Pre-heat the oven

2) Use the combination/fat tray or the fat tray!

The information given in bold shows you the **best oven function** to use in each case.



Baking at several shelf positions

Type of Cake or Pastry	Fan Cooking 			Time Hr.: Min.
	Shelf Position from the Top		Tempera- ture °C	
	2 Levels	3 Levels		
Cakes and Pastries on Baking Sheets				
Cream Puffs/Eclairs	2. and 5.	-	170-180	0:35-0:60
Dry Streusel Cake	2. and 5.	-	140-160	0:30-0:60
Pizza & baking	2. and 5.	-	170-190	0:40-0:70
Biscuits				
Shortcrust Biscuits	2. and 5.	1. 3. and 5.	150-160	0:15-0:35
Small Piped Biscuits	2. and 5.	1. 3. and 5.	140-150	0:20-0:60
Sponge Fingers	2. and 5.	1. 3. and 5.	160-170	0:25-0:40
Meringues	2. and 5.	-	80-100	2:10-2:50
Macaroons	2. and 5.	1. 3. and 5.	100-120	0:40-1:20
Small Pastries with Yeast	2. and 5.	-	160-170	0:30-0:60
Small Pastries made from Puff Pastry	2. and 5.	-	170-180 ¹	0:30-0:50
Bread Rolls	2. and 5.	-	180-190 ¹	0:30-0:55





Tips on Baking

	Tip
This is how to tell if your cake is cooked through	Push a wooden skewer into the highest point of the cake. When no more cake mixture sticks to the wood, you can switch off the oven and utilise the residual heat.
The cake collapses (is sticky, not properly cooked through, water marks)	Check your recipe. Next time use less liquid. Observe mixing times, particularly when using kitchen appliances.
The cake is too light	Next time select a dark cake tin or place the cake one level lower.
Cake with moist topping/ cake is not cooked through, is unevenly browned	Next time bake at a lower temperature and increase the cooking time.

Pies and Gratins Table

	Conventional 		Rothitherm 		Time Hr.: Min.
	Shelf Position from the top	Temperature °C	Shelf Position from the top	Temperature °C	
Pasta Bake	4.	200-220	3.	160-170	0:45-1:00
Lasagne	3.	180-200	3.	160-170	0:25-0:40
Gratinated Vegetables	3.	22-230	3.	160-170	0:15-0:30
Browned Baguettes	3.	230-240	3.	160-170	0:15-0:30
Sweet Puddings	4.	200-220	-	-	0:40-0:60
Fish Pies	3.	210-220	3.	160-170	0:30-1:00
Stuffed Vegetables	3.	220-250	3.	160-170	0:30-1:00

Frozen Ready Meals Table

Food to be Cooked	Shelf Position from the Top	Oven Function	Temperature	Time
Frozen Pizza	3.	Conventional 	In accordance with maker's instructions	In accordance with maker's instructions
Chips ¹ (300-600 g)	2.	Rothitherm 	200-220 °C	15-25 Min.
Baguettes	2./3.	Conventional 	In accordance with maker's instructions	In accordance with maker's instructions
Fruit Flan	2./3.	Conventional 	In accordance with maker's instructions	In accordance with maker's instructions

1) Comment: Turn chips 2-3 times during cooking.

Roasting

For roasting, use the rothitherm  or conventional  oven function.



Important: Use the fat filter when roasting!

Roasting Dishes



- Any heat-resistant dish is suitable for roasting.
- In the case of dishes with plastic handles, ensure that the handles are heat-resistant.
- Large roasts can be roasted **directly on the universal sheet or on the shelf with the universal sheet underneath** (e.g. turkey, goose, 3-4 chickens, 3-4 knuckles).
- We recommend roasting all lean types of meat **in a casserole with a lid** (e.g. veal, pork or beef pot roasts, frozen meat). This way the meat will remain juicier.
- You can roast all types of meat that should have a crispy exterior **in a casserole without a lid** (e.g. pork, meat loaf, lamb, mutton, duck, 1-2 knuckles, 1-2 chickens, small poultry, sirloin, fillet, game).
- **Tip:** If you use dishes for roasting (particularly for small amounts), the oven will not get so dirty!

Shelf Positions

- Please see the following table for the shelf positions to use.

Notes on the Roasting Tables

Information is given in the table on suitable oven functions, temperature settings, cooking times and shelf positions for various types of meat. The cooking times are only for guidance.



- We recommend roasting meat and fish **in the oven from a weight of 1 kg**.
- In general the conventional  function is suitable for very lean meat, fish and game. For all other types of meat (particularly poultry) we recommend the rothitherm  function.
- The cooking time required is dependent on the type and quality of the meat.
- To stop juices that exude from the meat burning onto dishes, we recommend adding a little liquid in the roasting dish.
- Turn the roast after approx. 2/3 of the cooking time.



Switch off the oven 10-15 minutes before the end of the cooking time to make use of the residual heat.

Roasting Table

Type of Meat	Quantity Weight	Conventional 		Roththerm 		Time Hr.:Min.
		Shelf Position from the Top	Tempera- ture °C	Shelf Position from the Top	Tempera- ture °C	
Beef						
Pot Roast	1-1.5 kg	4.	200-250	–	–	2:00-2:30
Sirloin or Fillet						per cm height
- red inside	per cm height	4.	250-270 ¹	4.	190-200	0:05-0:06
- pink inside	per cm height	4.	250-270 ¹	4.	180-190	0:06-0:08
- cooked through	per cm height	4.	210-250 ¹	4.	170-180	0:08-0:10
Pork						
Schoulder, Neck Joint of Ham	1-1.5 kg	4.	210-220	4.	160-180	1:30-2:00
Chop, Kassler	1-1.5 kg	4.	180-190	4.	170-180	1:00-1:30
Meat Loaf	750g-1 kg	4.	170-180	4.	160-170	0:45-1:00
Knuckle of Pork (pre-cooked)	750g-1 kg	4.	210-220	4.	150-170	1:30-2:00
Veal						
Roast Veal	1 kg	4.	210-220	4.	150-170	1:30-2:00
Knuckle of Veal	1,5-2 kg	4.	210-225	4.	150-170	2:00-2:30
Lamb						
Leg of Lamb, Roast Lamb	1-1.5 kg	4.	210-220	4.	150-170	1:15-2:00
Saddle of Lamb	1-1.5 kg	4.	210-220	4.	160-180	1:00-1:30

Type of Meat	Quantity Weight	Conventional 		Rothitherm 		Time Hr.:Min.
		Shelf Position from the Top	Tempera- ture °C	Shelf Position from the Top	Tempera- ture °C	
Game						
Saddle of Hare, Leg of Hare	up to 1 kg	3.	220-250¹	3.	160-170	0:25-0:40
Saddle of Venison	1,5-2 kg	4.	210-220	4.	160-170	1:00-1:30
Leg of Venison	1,5-2 kg	4.	200-210	4.	150-160	1:15-1:50
Poultry						
Poultry Pieces 4-6 pieces	per 200-250g	3.	220-250	3.	180-200	0:35-0:50
Chicken Halves 2-4 pieces	per 400-500 g	3.	220-250	3.	180-200	0:35-0:50
Chicken, Poulard	1-1.5 kg	4.	220-250	4.	170-180	0:45-1:15
Duck	1,5-2 kg	4.	210-220	4.	160-180	1:00-1:30
Goose	3.5-5 kg	5.	200-210	5.	150-160	2:30-3:00
Turkey	2.5-3.5 kg 4-6 kg	5.	200-210	5.	150-160	1:30-2:00
		5.	180-200	5.	140-150	2:30-4:00
Fish (steaming)						
Whole Fish	1-1.5 kg	4.	210-220	4.	160-170	0:45-1:15

1) Pre-heat oven.

The information given in bold shows you **the best oven function** for the respective dish.

Meat Thermometer Table

Food to be Cooked		Meat Core Temperature
Beef		
Pot Roast		90 – 95 °C
Entrecote or fillet steak	red inside (English)	45 – 50 °C
	pink inside (medium)	60 – 65 °C
	cooked through	75 – 80 °C
Pork		
Shoulder of Pork, Joint of Ham, Neck		80 – 82 °C
Chop (saddle), Kasseler		75 – 80 °C
Meat Loaf		75 – 80 °C
Veal		
Roast Veal		75 – 80 °C
Knuckle of Veal		85 – 90 °C
Mutton / Lamb		
Leg of Mutton		80 – 85 °C
Saddle of Mutton		80 – 85 °C
Roast Lamb, Leg of Lamb		75 – 80 °C
Game		
Saddle of Hare		70 – 75 °C
Leg of Hare		70 – 75 °C
Whole Hare		70 – 75 °C
Saddle of Venison		70 – 75 °C
Leg of Venison		70 – 75 °C

Grilling

Use the grill  oven function with a temperature of 275 °C for grilling.



Important: Always **pre-heat** the empty oven for **5 minutes using the grill function!**

It is not necessary to use the fat filter.

Ovenware for Grilling

- Use the shelf and fat tray together for grilling.

Shelf Positions

- When grilling flatter foods, always use the **2nd shelf position from the top.**

Notes on the Grilling Table

The grilling times are only for guidance and are dependent on the type and quality of the meat or fish.

- Grilling is particularly suitable for flat pieces of meat and fish.
- Turn pieces of meat or fish halfway through grilling.



Warning: Always grill with the oven door shut. There is a risk of burns!

Grilling Table

Food for Grilling	Shelf Position from the top	Grilling Time	
		1st Side	2nd Side
Rissoles	2.	8-10 Min.	6-8 Min.
Fillet of Pork	2.	10-12 Min.	6-10 Min.
Grilled Sausages	2.	8-10 Min.	6-8 Min.
Beef Fillet Steaks, Veal Steaks	2.	6-7 Min.	5-6 Min.
Fillet of Beef, Sirloin (approx. 1 kg)	2.	10-12 Min.	10-12 Min.
Sliced Bread for Toasting	2.	2-3 Min.	2-3 Min.
Toast with Topping	2.	6-8 Min.	-

Preserving

Use the fan cooking  oven function for preserving.

Preserving Jars

- Only use commercially available preserving jars (preserving jars with a rubber ring and glass lid) for preserving.
- Jars with screw or bayonet tops are unsuitable, as are metal tins.

Shelf Positions



- Use the **4th shelf position from the top** for preserving.

Notes on Preserving



- Use the universal sheet for preserving. There is room on this sheet for up to 6 preserving jars of 1 litre capacity.
- Pour a cup of water onto the universal sheet to ensure that there is sufficient humidity.
- Position the preserving jars on the universal sheet such that they do not touch each other.
- The preserving jars should all be filled the same amount and closed.

Preserving Times

Fruit and Pickled Gherkins

-  1. Select the fan cooking  oven function and **change the suggested temperature to 160 °C**.
2. As soon as bubbles begin to form in the liquid in some of the jars (in the case of 1 litre jars after approx. 45 minutes), switch off the oven.
3. Leave the jars to stand in the closed oven for a further 30 minutes – in the case of delicate fruits, e.g. strawberries, approx. 15 minutes.

Vegetables and Meat

-  1. Select the fan cooking  oven function and **change the suggested temperature to 160°C**.
2. As soon as bubbles begin to form in the first jars, lower the temperature to 100 °C.
3. Continue to cook at 100 °C for approx. 60-90 minutes.
4. Then switch off the oven and leave the preserving jars to stand in the closed oven for a further 30 minutes.

Cleaning and Care

The Exterior of the Appliance

-  Wipe the front of the appliance with a soft cloth and warm water with washing up liquid.
 - Do not use scourers, caustic cleaners or abrasive items.
 - In the case of stainless steel fronts, you may use commercially available stainless steel cleaners. These also provide a protective film against finger marks.

Oven Interior

Oven Lighting

You can switch on the oven light to make cleaning easier.

Cleaning

-  **1.** Wipe the oven clean after each use with water and washing up liquid with a little vinegar added.
- 2.** Then rub the oven dry with a cloth.
- 3.** Remove stubborn marks with special oven cleaner.



Warning: Do not clean the appliance with a steam or high pressure cleaner for safety reasons.

Important: When using oven spray, please ensure that you follow the manufacturer's instructions.

Accessories

-  After each use rinse all slide-in parts (shelf, etc.) and dry well. Soak briefly to make them easier to clean.

Fat Filter

-  **1.** Clean the fat filter in hot water and washing up liquid, or in your dishwasher.
- 2.** In the case of burnt on soiling, boil in a little water with 2-3 dessert spoons of dishwasher detergent.

Side Rails

The side rails on the left and right hand sides of the oven can be removed for cleaning the side walls.

Removing and Fitting the Side Rails.

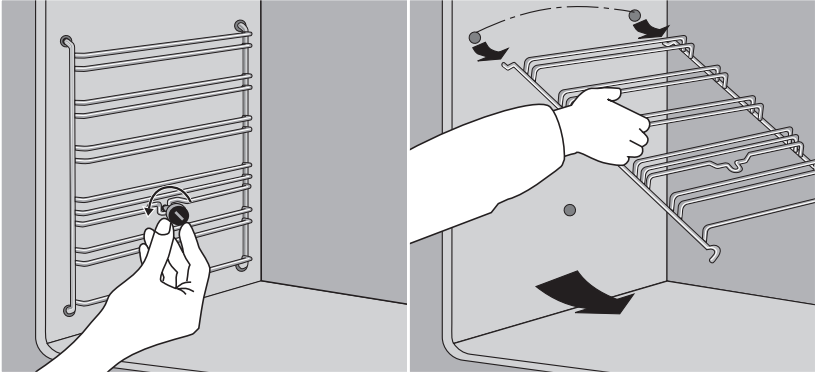

1. Undo the bolt (if necessary use a coin).
2. Pull the base of the side rail forwards and unhook at the top.
3. To refit, insert the side rail at the top and place against the side of the oven.
4. Re-fit the bolt.

Grill Element

To make the cleaning of the oven roof easier, the grill element can be folded down.



Warning: Only fold down the grill when the oven is switched off and is cold.

Folding Down the Grill Element



Turn the two retaining hooks 90° (a quarter of a turn) towards the middle.

The heater element swings downwards.



Important: Do not use excessive force to lower the heater element. The heater element can break off if excessive force is used.

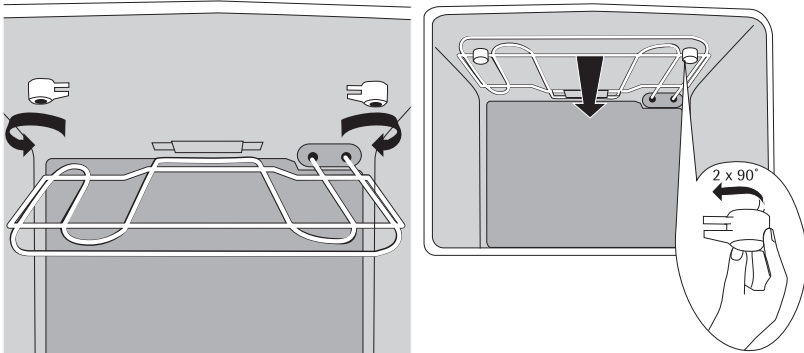

Fitting the Grill Element



Press the heater element gently upwards and turn the retaining hooks 90° towards the rear so that the heater element bracket is between the retaining hooks.



Important: Never slide the retaining hooks onto the heater element. There is a risk of fire.

Oven Light



Warning: There is a risk of electric shock! Before changing the light bulb in the oven:

- Switch off the oven!
- Isolate the oven from the power supply.

Replacing the Light Bulb in the Oven/Cleaning the Glass

1. Place a cloth on the floor of the oven.
2. Remove the glass cover by turning it anti-clockwise and then clean it.
3. **Oven lighting replace with 40 Watt, 230 V, 300 °C heat resistant light bulb.**
4. Refit the glass cover.
5. Remove the cloth from the oven.



Oven Door

The oven door on your appliance can be removed for cleaning.

Removing the Oven Door

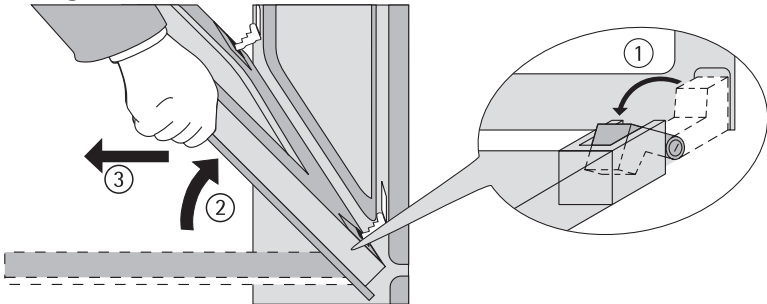

1. Open the oven door completely.
2. **Lift up fully the coloured clamping lever** on both door hinges (1).
3. Close the oven door around 3/4 of the way, **overcoming the resistance** (2).
4. Take hold of the side of the oven door with both hands. Lift the door upwards (Caution: heavy!) and remove from the oven (3).
5. Place the door, with the outer surface downwards, on a soft, flat surface, for example a blanket, to avoid scratches.

Hanging the Oven Door

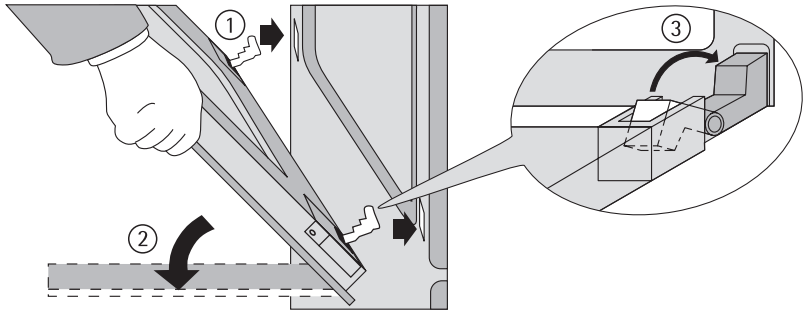

1. Take hold of the sides of the door with both hands from the handle side.
2. Hold the door at an angle of approx. 60°.
3. Slide the door hinges as far as possible into the two cut-outs on the right and left on the bottom of the oven (1).
4. Lift the door up until resistance is met and then open fully (2).
5. Turn the clamping levers on both door hinges back into their original position (3), so that the coloured marks again point upwards.
6. Close the oven door.

Oven Door Glass

The oven door is fitted with two panes of glass, these are fitted one behind the other. The inner pane can be removed for cleaning.



Warning: Please only perform the following steps on the oven door when it has been removed from the oven! When the door is fitted, the reduction in the weight of the door when the glass is removed could lead to the door suddenly closing and creating a hazard.

Removing the Door Inner Glass

1. Remove the oven door and place on a soft, level surface with the handle downwards.
2. Take hold of the pane of glass at the upper edge and slide it against the spring pressure in the direction of the oven door handle until it is free at the base (1).
3. Lift the pane **gently** at the base and remove (2).

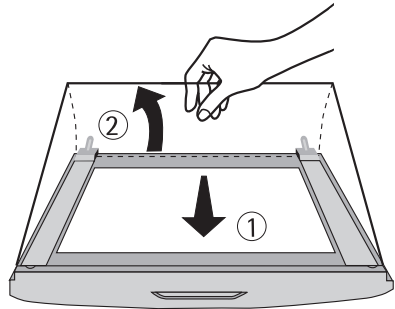

Replacing the Inner Door Glass

1. Guide the pane of glass at an angle from above into the door section on the handle side (1).
2. Lower the pane of glass (2). Place the pane, against the force of the spring on handle side, in front of the retaining section on the lower edge of the door and **slide it under the retaining section**. The pane of glass must sit securely!
3. Refit the oven door.

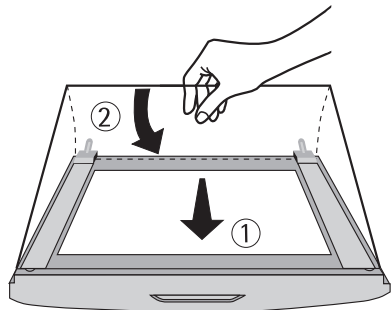

What to do if ...

.... the oven does not heat up?



Check whether

- the appliance is switched on
- the time is set,
- all the necessary settings have been made,
- the mains fuse (fuse box) has blown.

If the fuse blows several times, please call an electrician.

.... the oven lighting ceases to function?



Replace the oven light bulb (see Cleaning and Care).

If you call in an engineer to resolve a problem listed in these notes, or due to an operating error, the customer service engineer's visit is not cost free, even during the warranty period.



If this information does provide you with the necessary assistance, please seek specialist advice.



Warning: Repairs to the appliance must be carried out by qualified service engineers! Improper repairs can give rise to significant hazards for the user. If your appliance needs repairing, please contact your local AEG Service Force Centre.

Special accessories

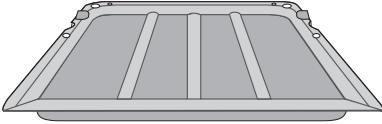
You can purchase the following accessories for your appliance from your dealer:

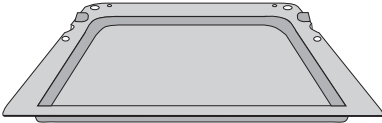
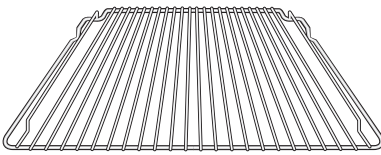
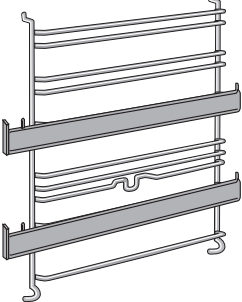
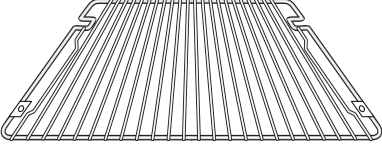
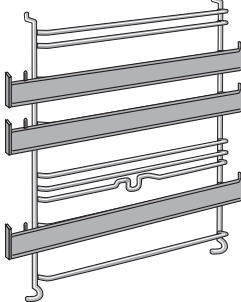
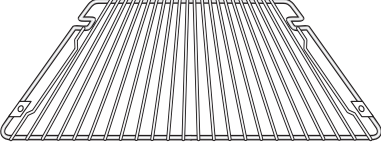
<p>Roasting/Fat Tray E-Nr. 611 898 624</p>  A rectangular tray with a slightly raised rim and three vertical ridges running down the center.	<p>Universal Sheet E-Nr. 611 898 626</p>  A rectangular tray with a slightly raised rim and a smooth, flat surface.
<p>Baking Sheet E-Nr. 611 898 620</p>  A rectangular tray with a slightly raised rim and a smooth, flat surface, similar to the universal sheet but with a different rim profile.	<p>Combination Shelf (not suitable for the use with oven shelf runners) E-Nr. 944 189 010</p>  A rectangular wire mesh tray with a slightly raised rim.
<p>Oven Shelf Runners BAZ2 with Combination Shelf E-Nr. 944 189 014</p>   The image shows two views of the BAZ2 accessory: a side view of a metal frame with two horizontal runners and a top-down view of the wire mesh combination shelf.	<p>Oven Shelf Runners BAZ3 with Combination Shelf E-Nr. 944 189 015</p>   The image shows two views of the BAZ3 accessory: a side view of a metal frame with three horizontal runners and a top-down view of the wire mesh combination shelf.

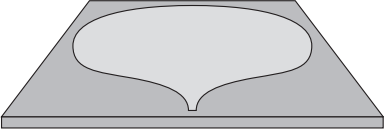
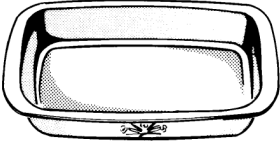
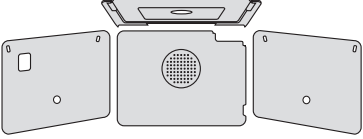
<p>Pizza & Baking Stoneware: H1.2 x B34.5 x D34.5cm E-Nr. 944 189 008</p> 	<p>Glass Ceramic Fat Tray: H6.5 x B32.0 x D27.0cm E-Nr. 611 899 660</p> 
<p>Catalytic Set KTF, 4 piece E-Nr. 944 189 030</p> 	
<p>2 Side Strips, white for white kitchen units E-Nr. 611 898 700</p>	<p>Stainless Steel Cleaner for all stainless steel appliances E-Nr. 944 190 002</p>

Installation Instructions



Important: Any electrical installation work must be carried out by a qualified electrician/competent person.

The oven must be installed according to the instructions supplied.

Technical Data

Oven Exterior Dimensions

Height x Width x Depth 60 cm x 56 cm x 55 cm

Oven Interior Dimensions

Height x Width x Depth 31 cm x 39.6 cm x 41 cm

Volume (useable) 54 l

Regulations, Standards, Directives

This appliance meets the following standards:

- EN 60 335-1 and EN 60 335-2-6
in respect of the safety of electrical appliances for household use and similar purposes and
- DIN 44546 / 44547 / 44548
in respect of the operating features of electric cookers for household use.
- EN 55014-2 / VDE 0875 part 14-2
- EN 55014 / VDE 0875 part 14/12.93
- EN 61000-3-2 / VDE 0838 part 2
- EN 61000-3-3 / VDE 0838 part 3
in respect of the basic protection requirements for electromagnetic compatibility (EMC).



This appliance complies with the following EU directives:

- 73/23/EWG dated 19.02.1973 (Low Voltage Directive)
- 89/336/EWG dated 03.05.1989 (EMC Directive including Directive Amendment 92/31/EWG).



Safety Instructions for the Installer

- In respect of fire protection, this appliance corresponds to type Y (IEC 335-2-6). Only appliances of this type may be installed next to a high cupboard or a wall.
- Contact protection must be guaranteed by the installation.
- The unit in which the appliance is fitted must satisfy the requirements of DIN 68930 in respect of stability.
- This oven must be installed by qualified personnel to the relevant Standards.
- This oven is heavy. Take care when moving it
- Remove all packaging, both inside and outside the oven before using the oven.
- Do not attempt to modify the oven in any way.

Installation

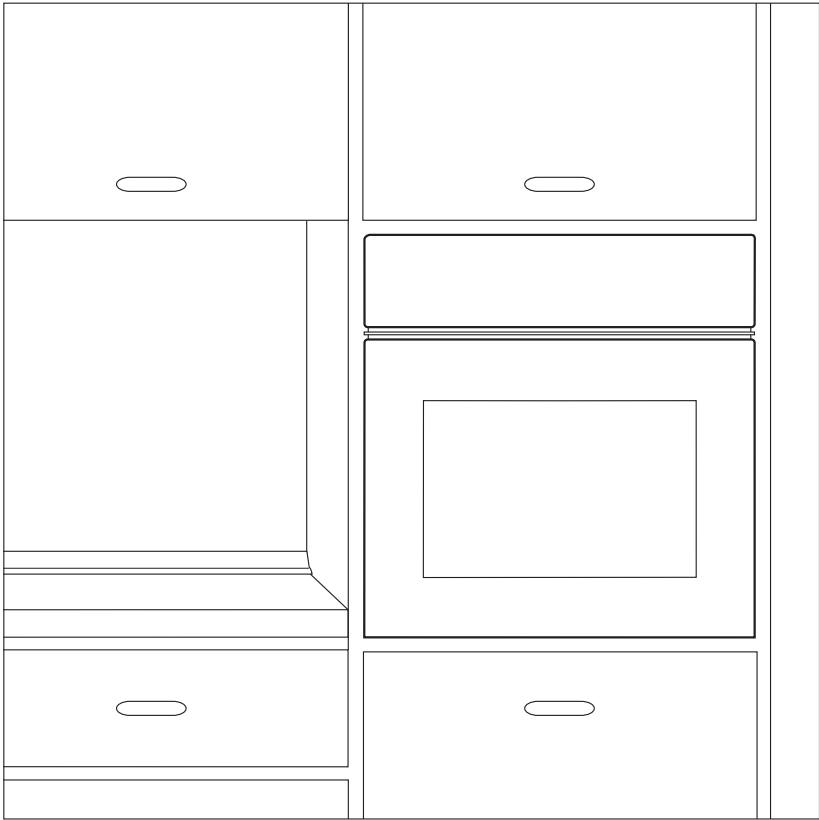

Information

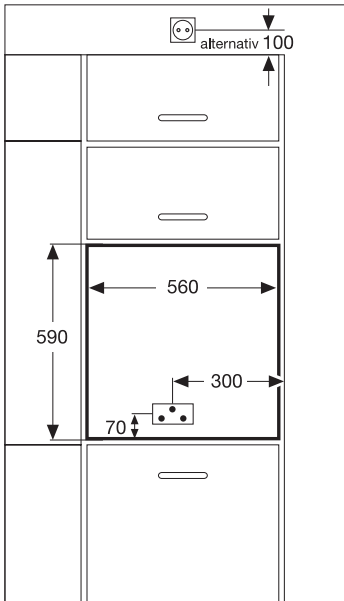
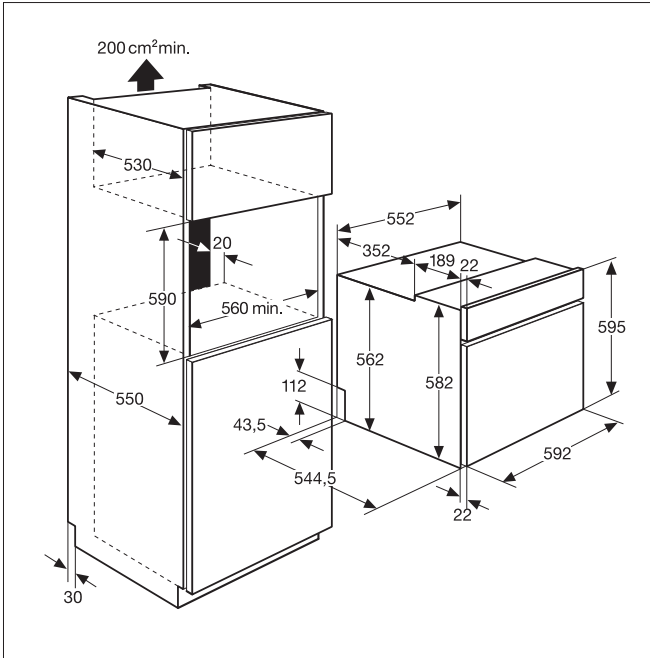

Preparing the Kitchen Units

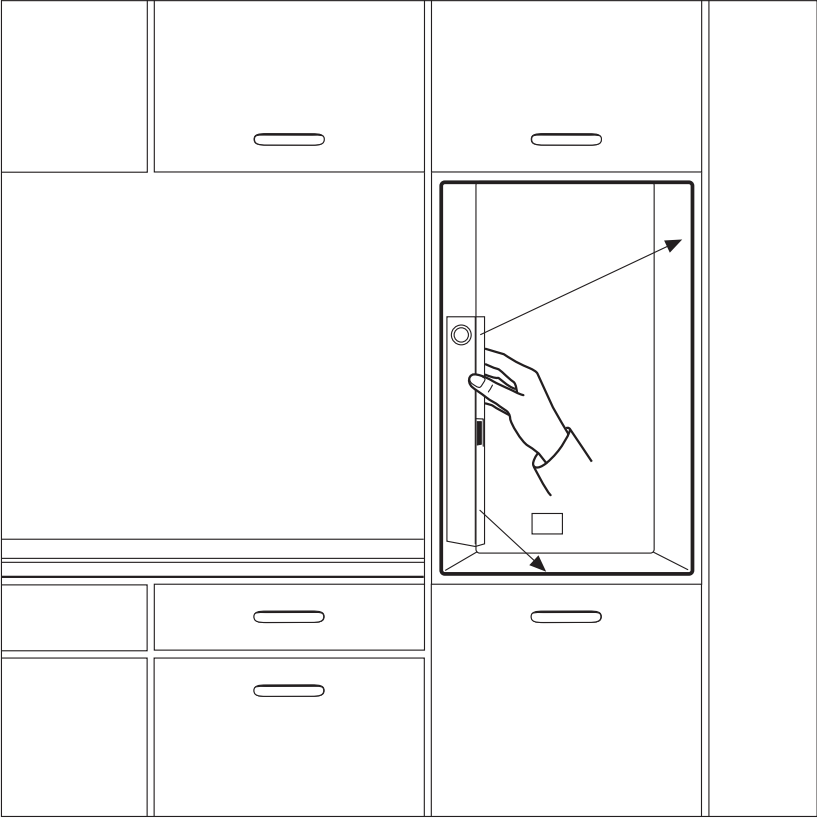

Electrical connection

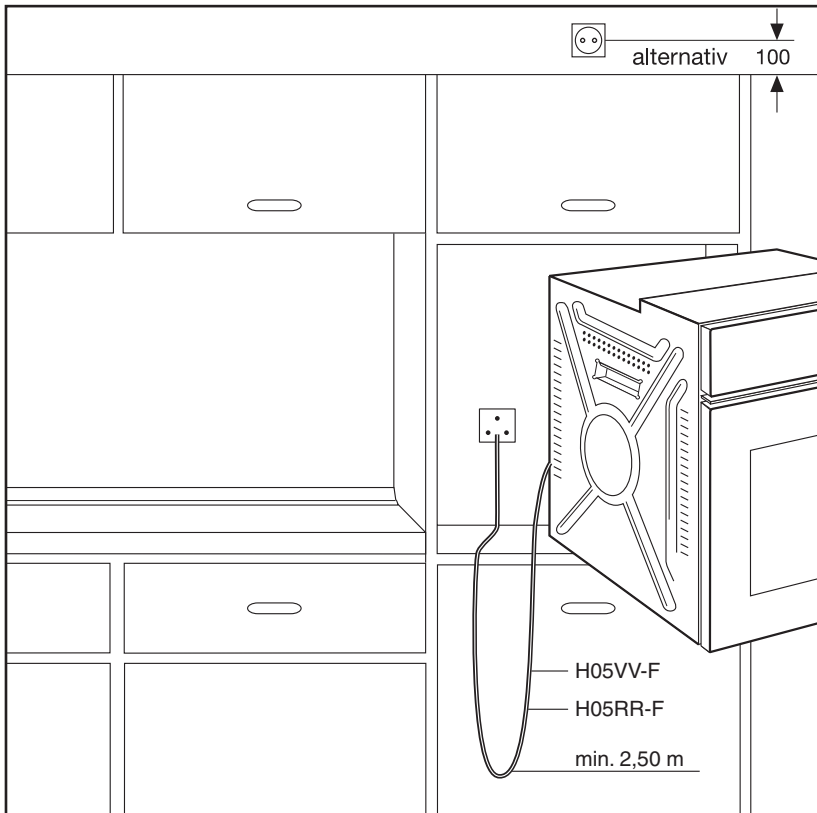
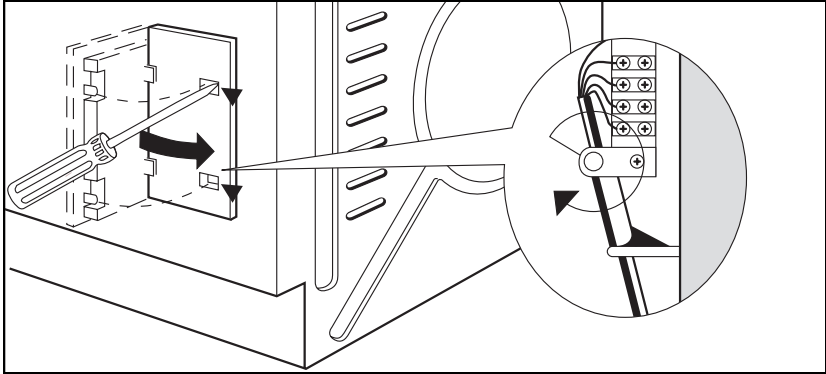

Fixing

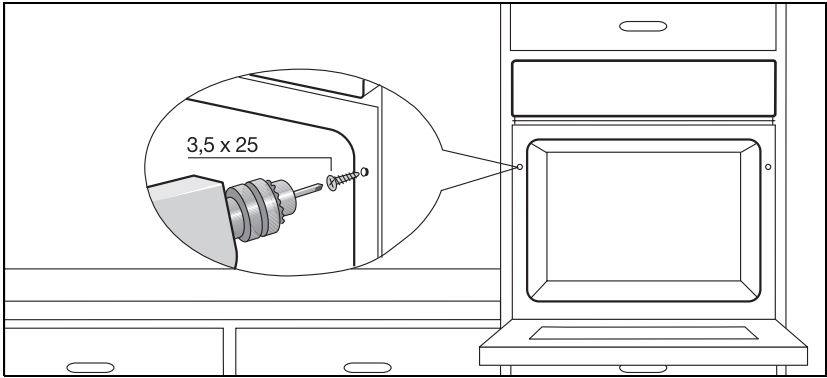
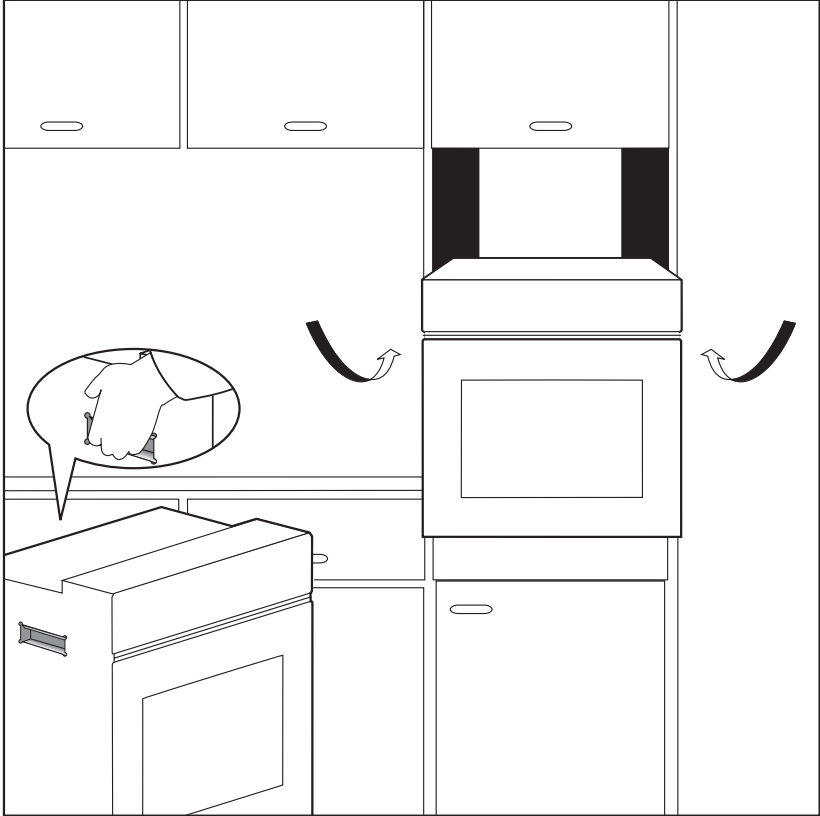

SERVICE

In the "What to do, if ..." section a number of malfunctions are listed that you can rectify yourself. In the event of a malfunction, look there first.

Is it a technical malfunction?

Then please contact your customer service centre. (You will find addresses and telephone numbers in the "Customer Service Centres" list.)

Always take the time to prepare yourself for the call. By this means you will make diagnosis of the problem easier and also make it easier to decide if a customer service visit is necessary:

Please determine as accurately as possible:

- How is the malfunction noticeable?
- Under what circumstances does the malfunction occur?

Prior to the telephone call it is imperative that you make a note of the following appliance code numbers that are given on the rating plate:

- PNC Code (9 digits),
- S-No Code (8 digits).

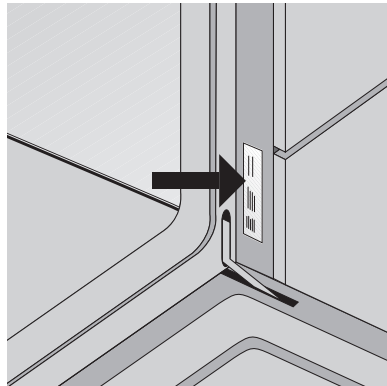

We recommend you to record the code numbers here so that you always have them at hand:

PNC

S-No

When will you be charged, also during the warranty period?

- when you could have rectified the malfunction with aid of the Table of Malfunctions (see "What to do, if ..." section),
- if the customer service engineer has to make several calls because he was not given important information prior to his visit, and therefore, e.g., had to fetch replacement parts. You can avoid multiple calls if you prepare yourself well for the telephone call, as described above.

AEG Hausgeräte GmbH
Postfach 1036
D-90327 Nürnberg

<http://www.aeg.hausgeraete.de>

© Copyright by AEG

ANC 822 947 090 - 07 - 0500